



**B-moved**<sup>®</sup>

Smart Home Technology



Smart Home  
Controllable



# B-moved

**Sistema elettrico per  
ante scorrevoli**

Electric system for  
sliding doors



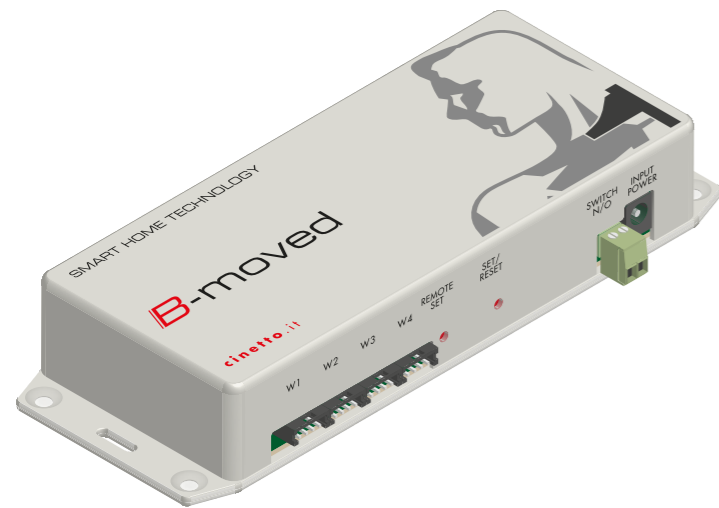

# B-moved

**Sistema elettrico per ante scorrevoli**  
Electric system for sliding doors

**Accessori complementari**  
Additional accessories

- Wave Sensor.
- Connettore per Home Assistant.  
Connector for Home Assistant device.
- PS40
- PS48
- PS66
- PS70

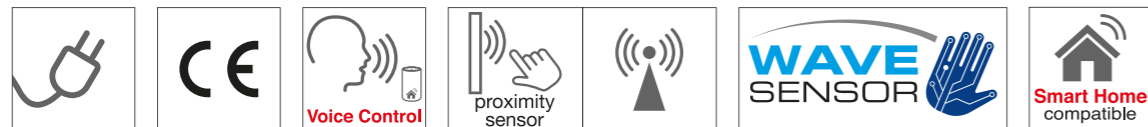

# B-moved, per una casa senza barriere.

B-moved, design a home without barriers.

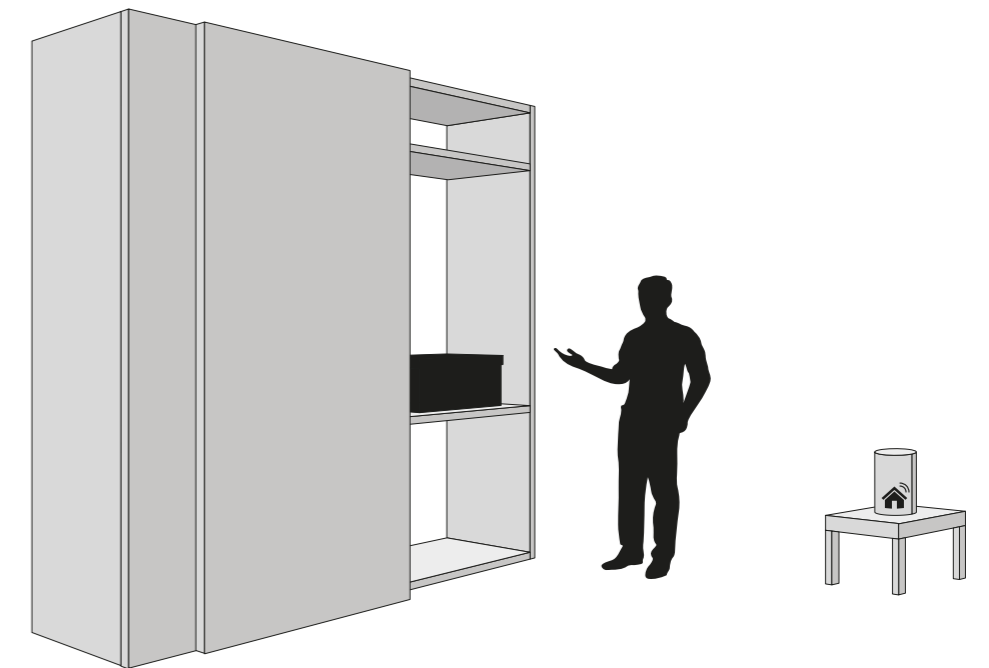
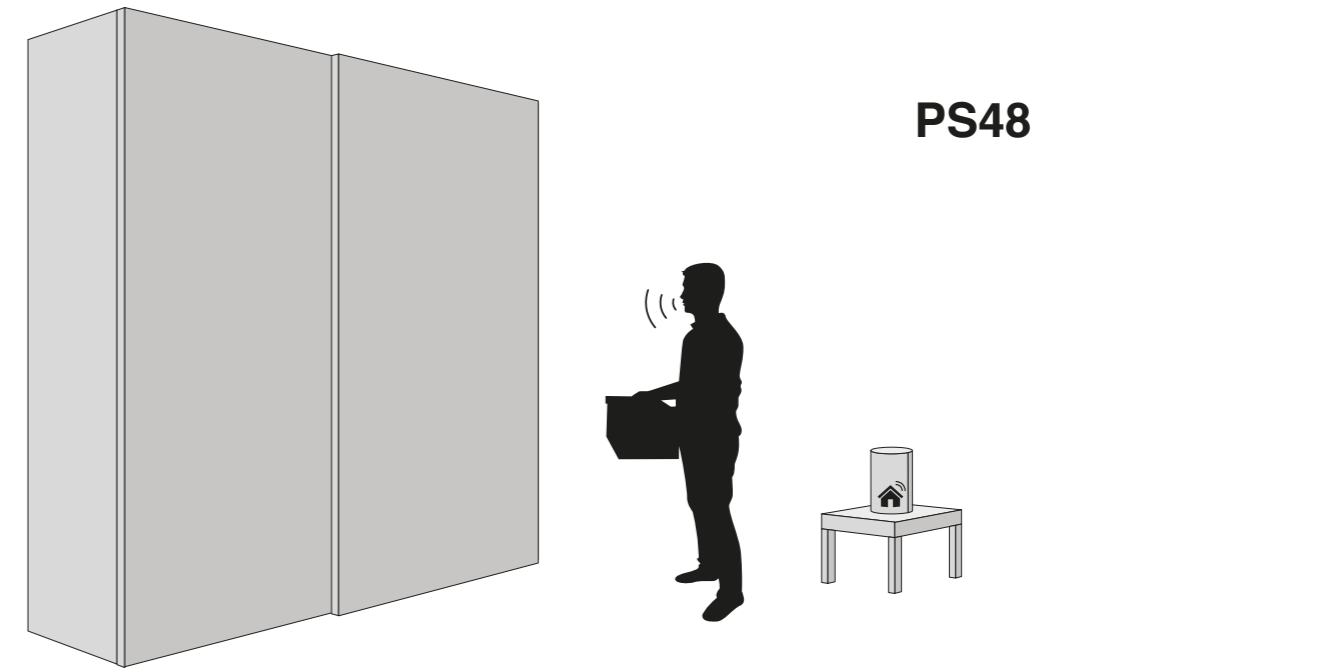

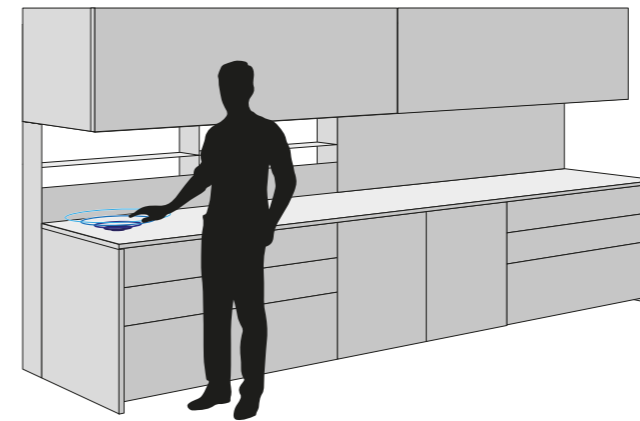
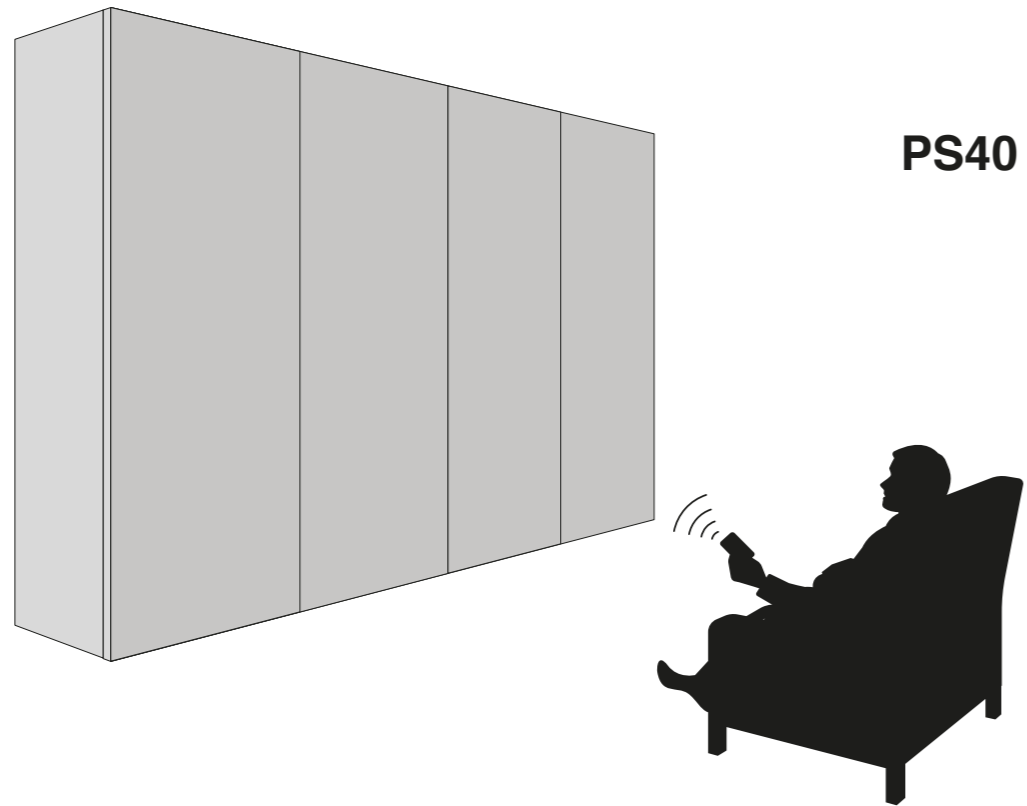

PS70

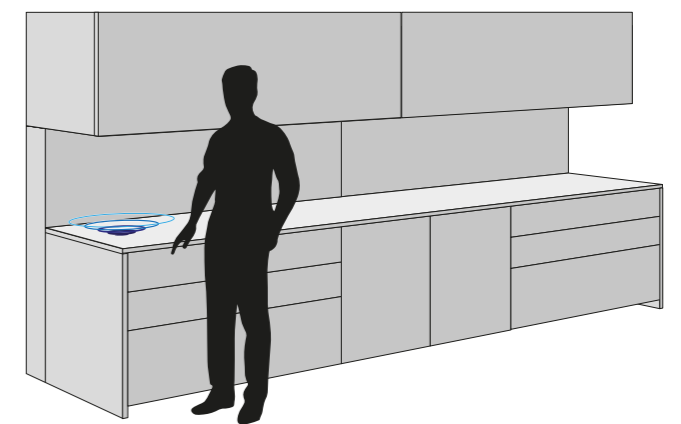
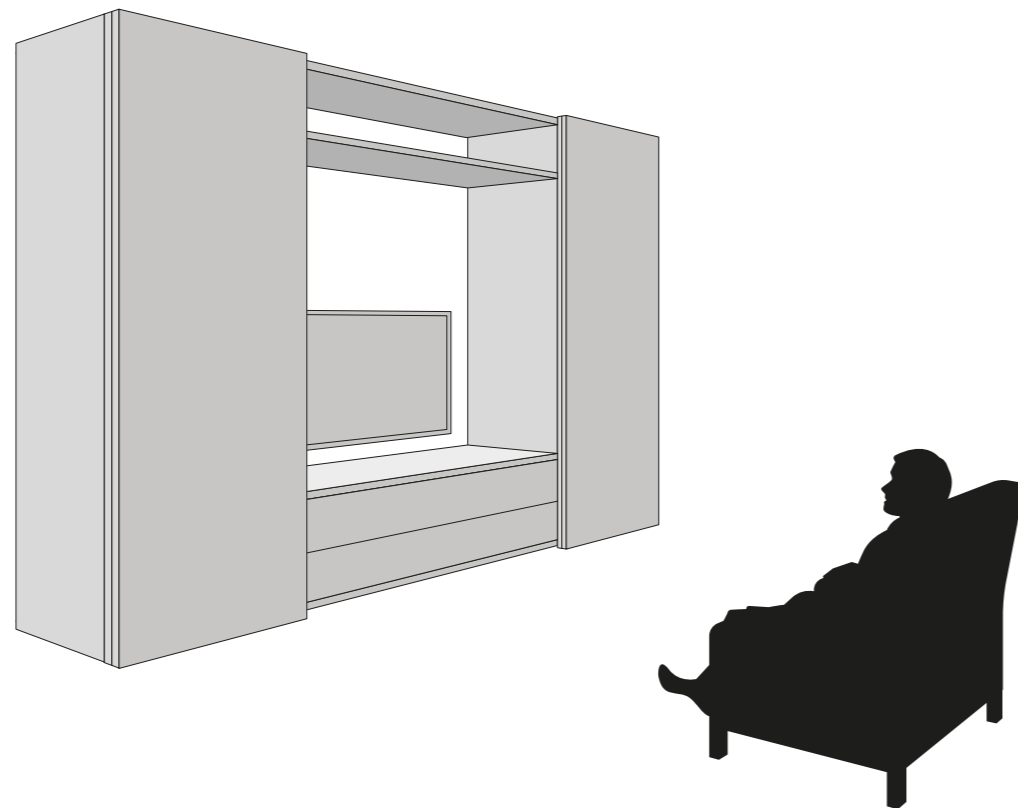

# B-moved, sicurezza certificata.

## B-moved, certificated system.

- **Il sistema si ferma in presenza di ostacoli.**  
The system stop in presence of obstacles.

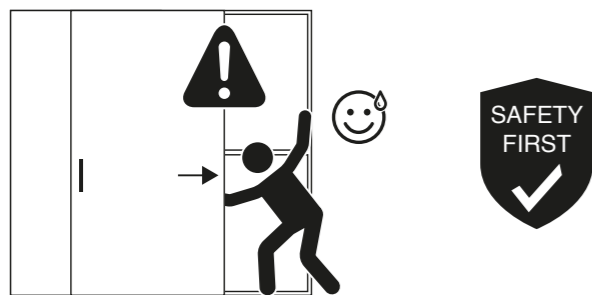

- **Isolamento delle componenti elettriche. Questo garantisce l'assenza di passaggio di elettricità all'armadio.**  
Insulation of electrical components. This guarantees the absence of electricity passing through the cabinet .

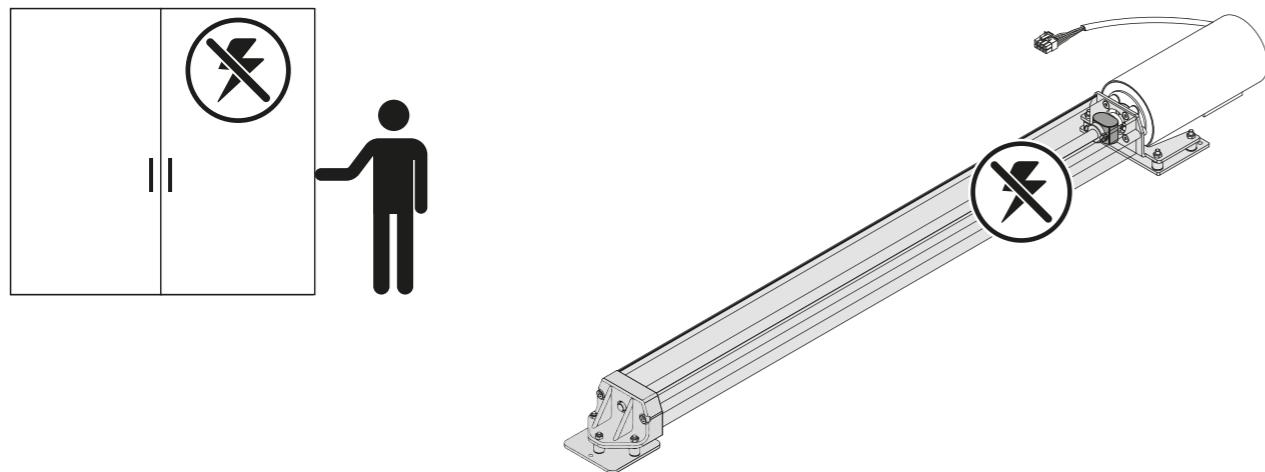

## B-moved. Sistema elettrico per ante scorrevoli / Electric system for sliding doors

- **B-moved ha conseguito la certificazione EMC la quale attesta che le onde elettromagnetiche da esso generate non sono dannose per la salute.**  
B-moved has obtained the EMC certification which certifies that the electromagnetic waves generated by it are not harmful to health.

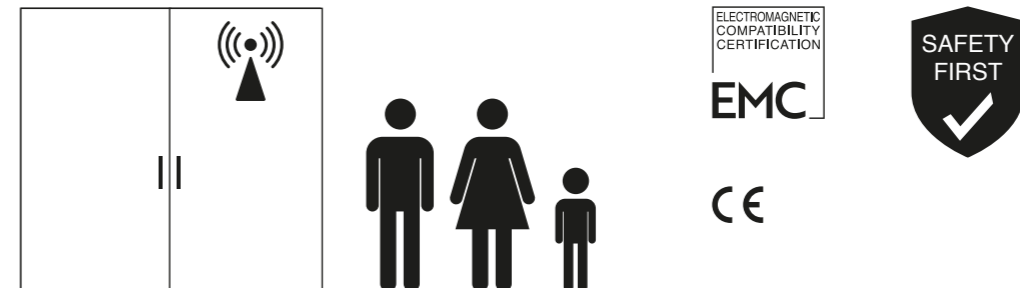

- **In caso di blackout il sistema permette di movimentare manualmente le ante.**  
In the event of a blackout, the system allows the doors to be moved manually.

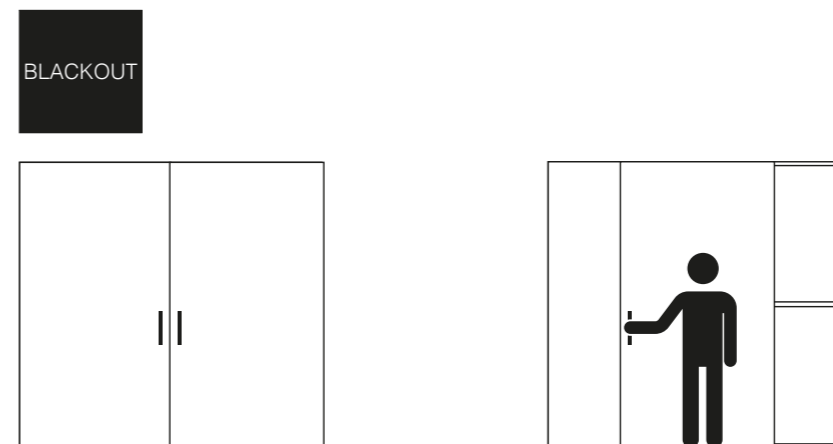

- **In caso di blackout improvviso, anche prolungato, il sistema non perde le configurazioni impostate al momento dell'installazione. Una volta ripristinata l'energia elettrica, l'impianto torna a funzionare senza bisogno di alcun intervento.**  
In the event of a sudden or even prolonged blackout, the system does not lose the configurations set at the time of installation. Once the electricity is restored, the system returns to work without any need for intervention.

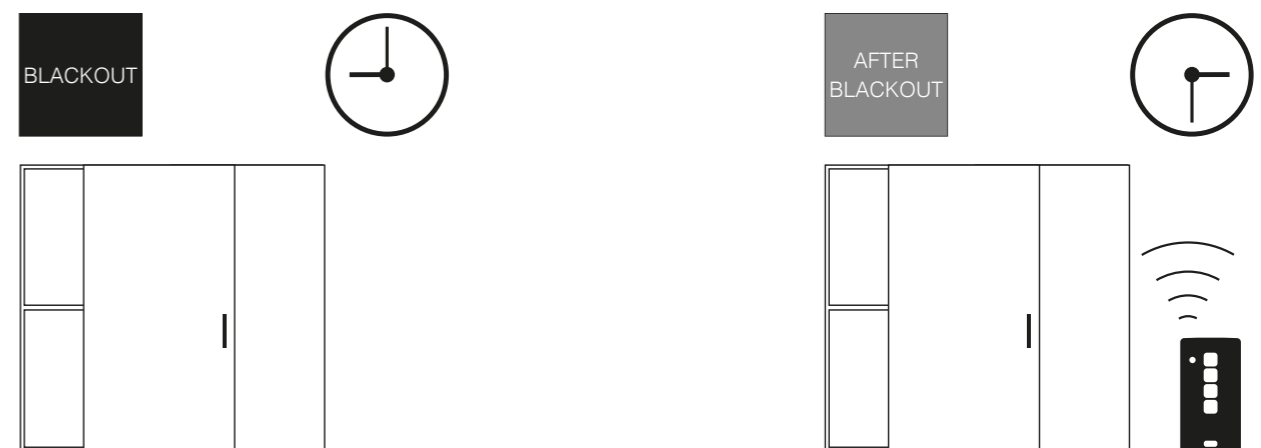

# B-moved, Smart Home Technology.

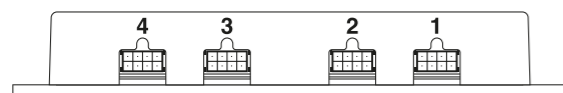
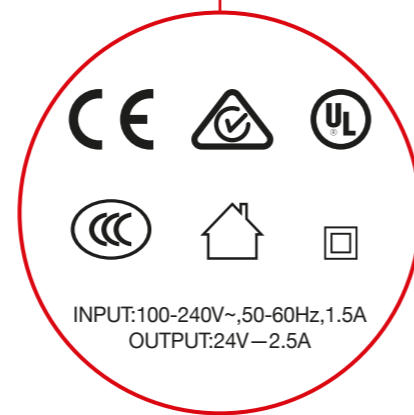
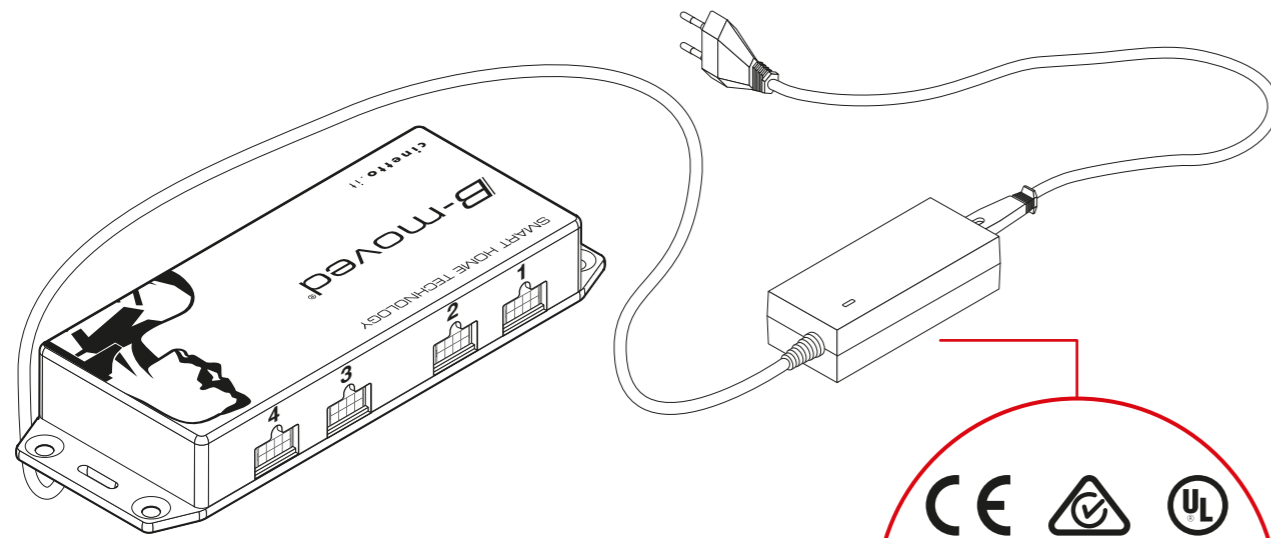

**Lato A**  
Side A

- **Ingressi per il controllo di quattro barre di trasmissione B-moved.**  
Inputs for controlling four B-moved transmission bars.

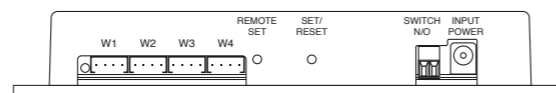

**Lato B**  
Side B

- **Ingressi per Wave Sensor.**  
Inputs for Wave Sensor.
- **Ingressi per connettore ausiliario di controllo.**  
Inputs for auxiliary control connector.
- **Ingresso per connessione alla rete elettrica.**  
Input for mains connection.
- **Switch.**  
Switch.

**B-moved.** Sistema elettrico per ante scorrevoli / Electric system for sliding doors

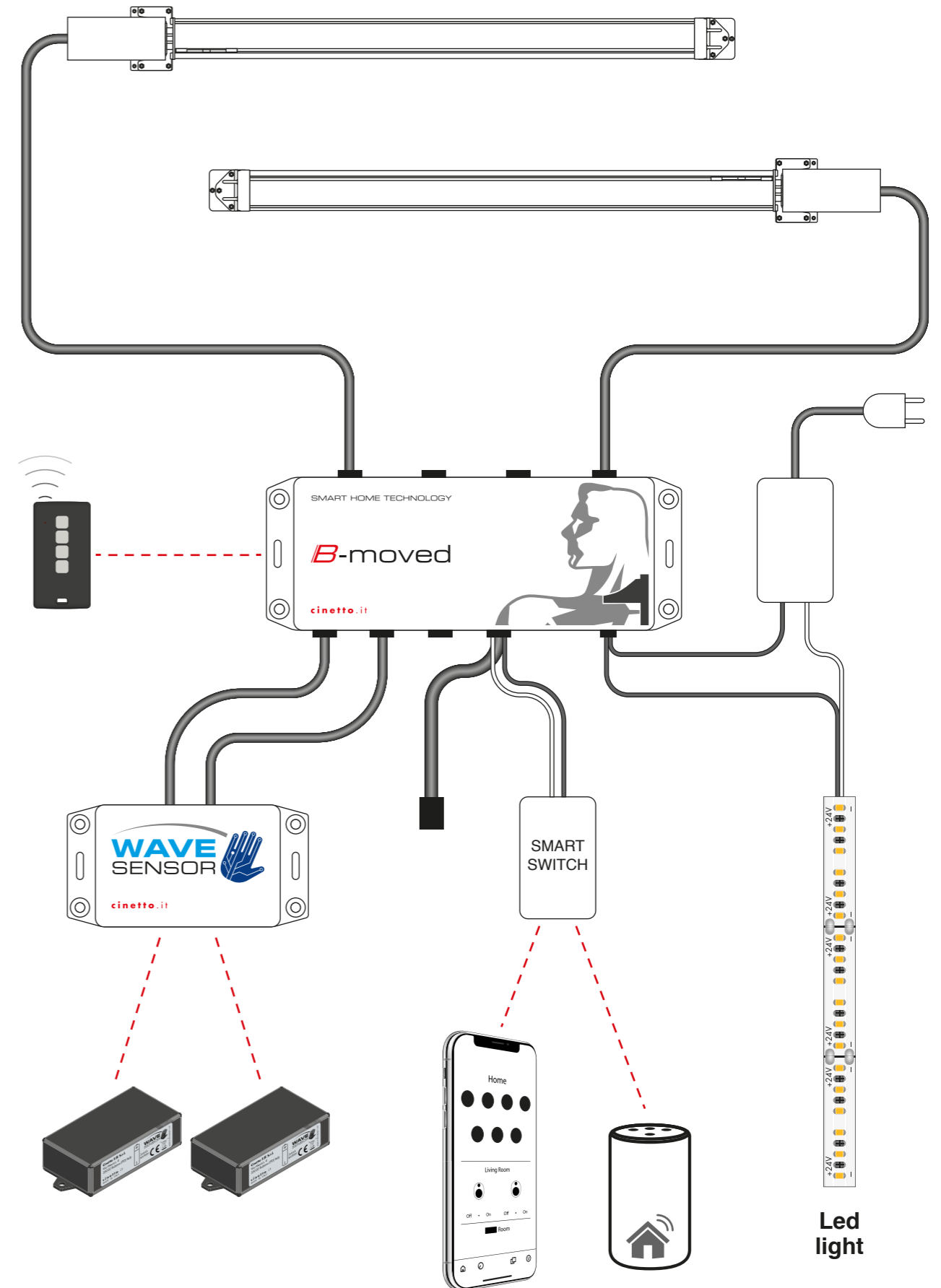

# B-moved, dispositivi di comando.

## B-moved, control devices.

**Standard (sempre incluso) / Standard (always included).**

■ **Telecomando.**  
Remote control.

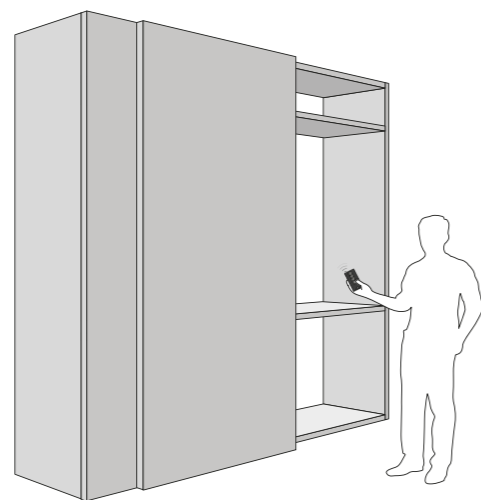
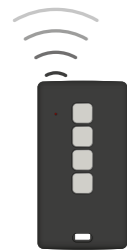

**B-moved.** Sistema elettrico per ante scorrevoli / Electric system for sliding doors

**Accessori opzionali / Optional devices.**

■ **Wave Sensor.**  
Page 14

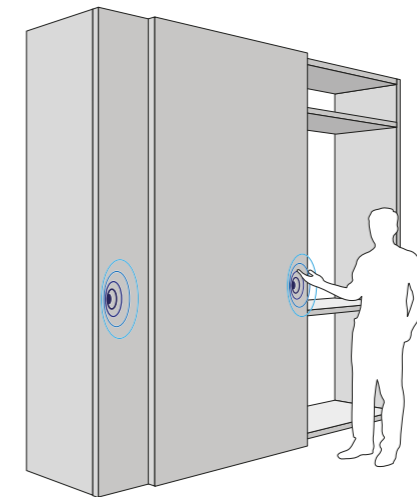
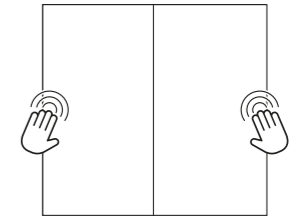
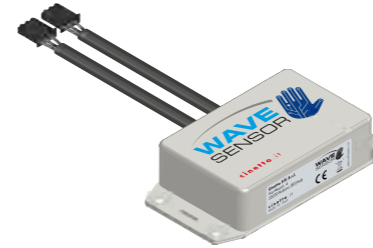

■ **Connettore per ingresso ausiliario di controllo / Connector for auxiliary control input.**  
Page 16

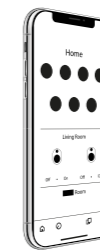

**Voice Control**

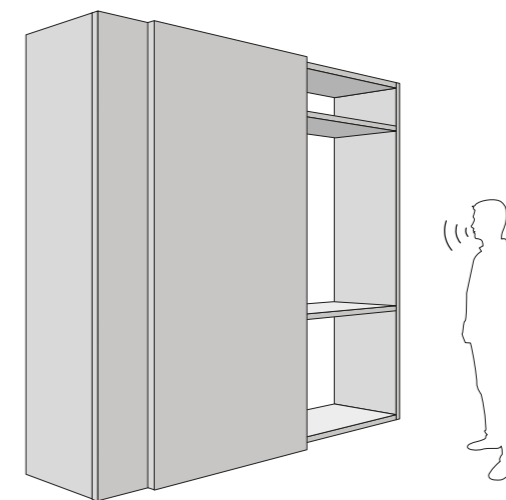

# Wave Sensor

**Sensore di prossimità wireless.**  
Wireless proximity sensor.

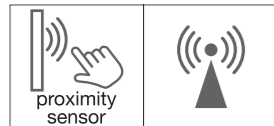

**Nuovo sistema di controllo delle ante tramite sensori di prossimità wireless.**  
New doors' control system via wireless proximity sensors.

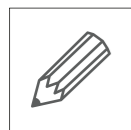

**Fino a 10 sensori per anta.**  
Up to 10 sensors each door.

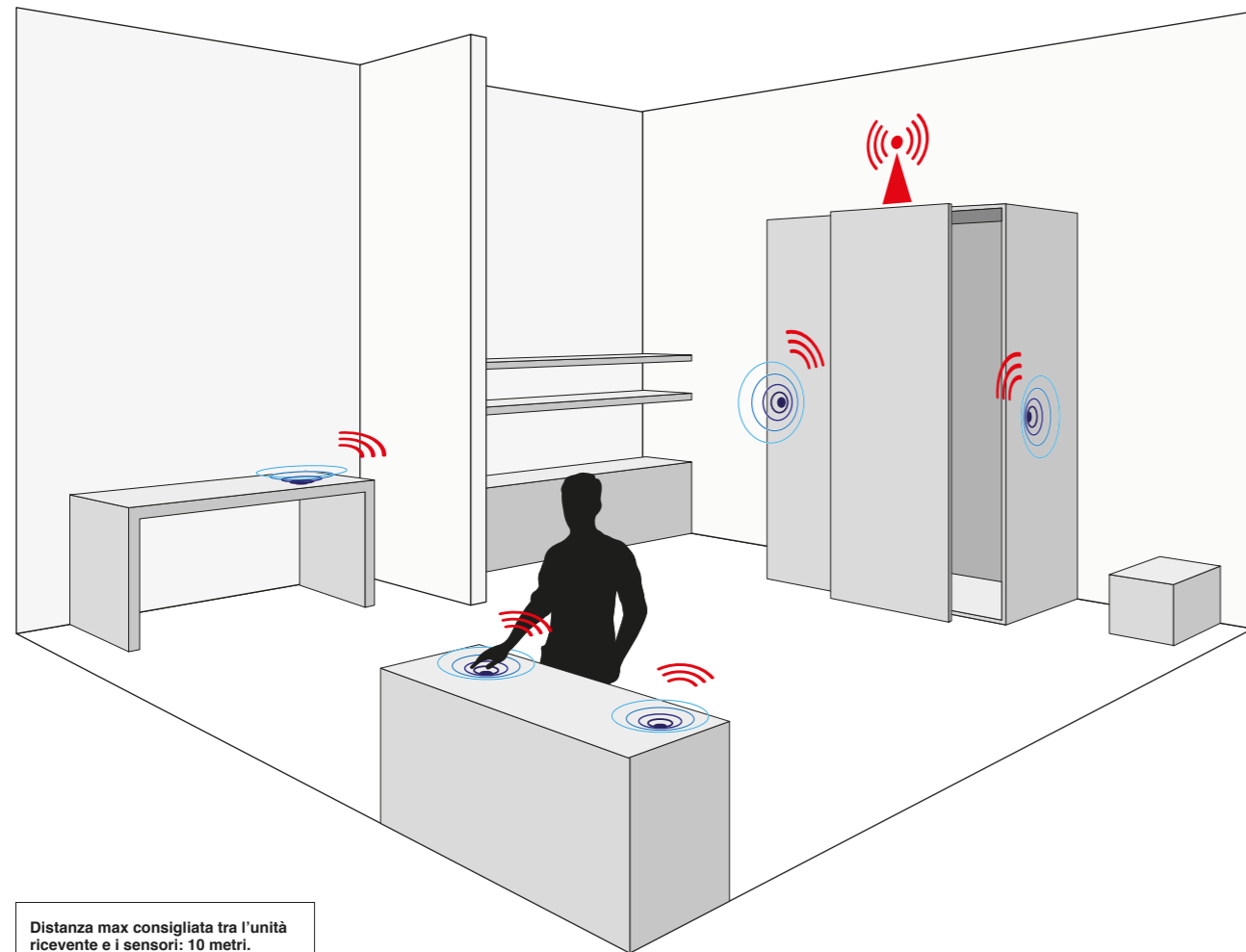

**Distanza max consigliata tra l'unità ricevente e i sensori: 10 metri.**  
Max recommended distance between receiver unit and sensors: 10 meters.

**B-moved.** Sistema elettrico per ante scorrevoli / Electric system for sliding doors

**Posizionamento Wave Sensor.**  
Wave Sensor positioning.

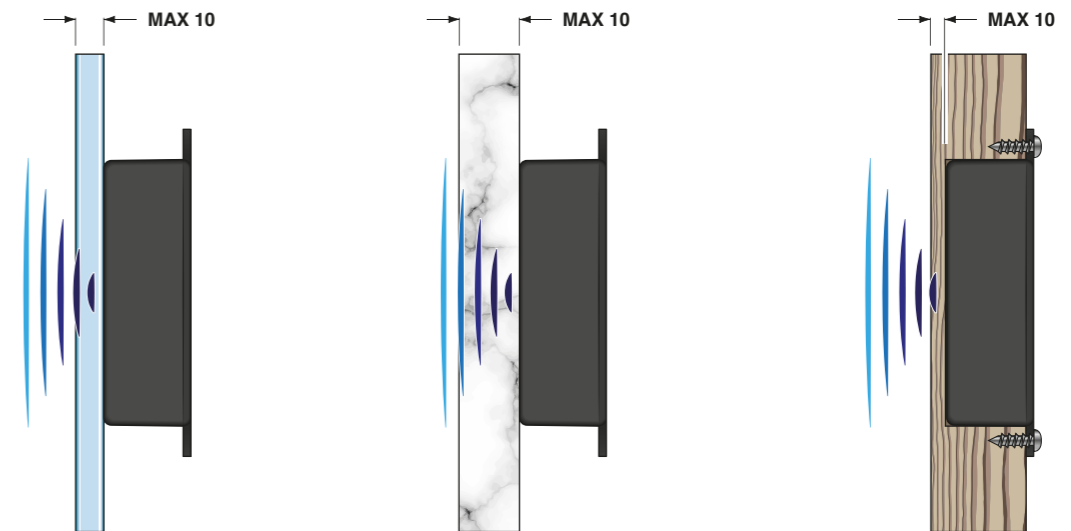

**! Non posizionare Wave Sensor dietro materiali metallici, conduttivi o specchi.**  
Do not place Wave Sensor behind metallic, conductive materials or mirrors.

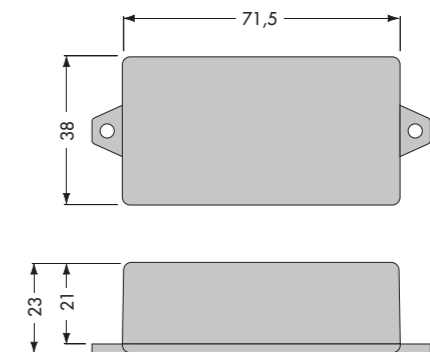

**option**

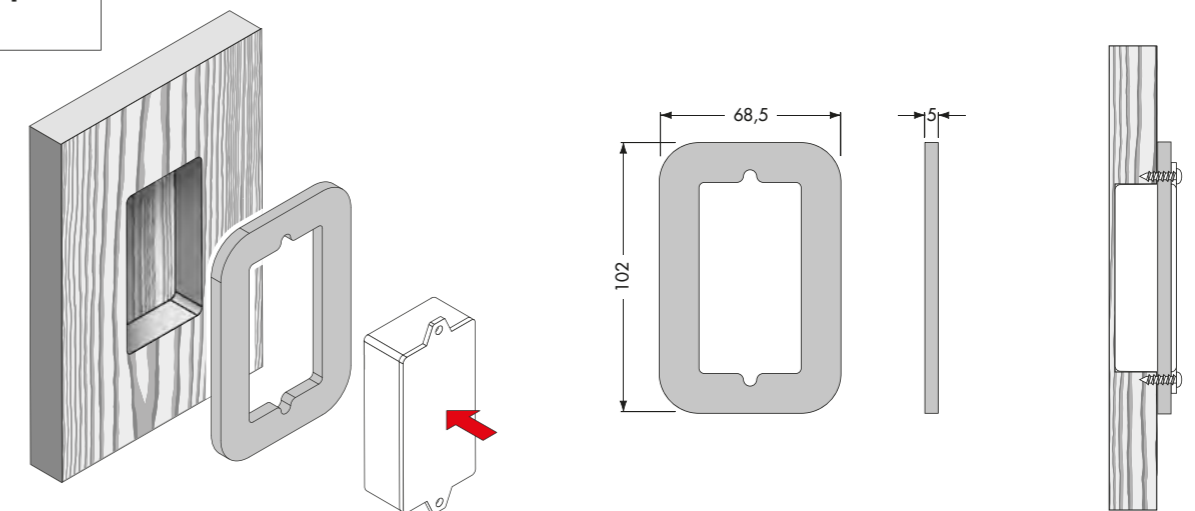



# B-moved & connettore per ingresso ausiliario di controllo.

B-moved & connector for auxiliary control input.

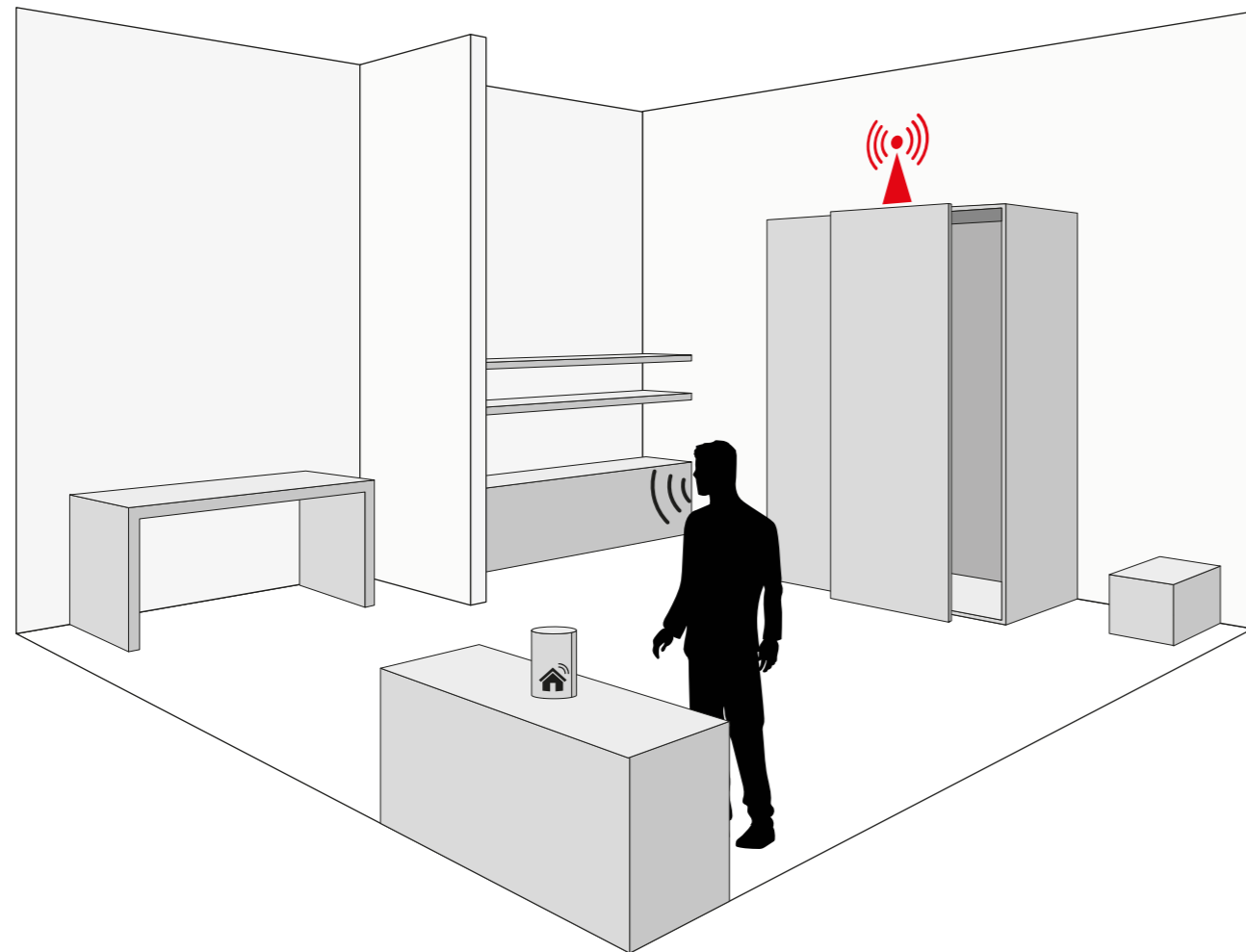

**B-moved.** Sistema elettrico per ante scorrevoli / Electric system for sliding doors

**Connettore per ingresso ausiliario di controllo.**  
Connector for auxiliary control input.

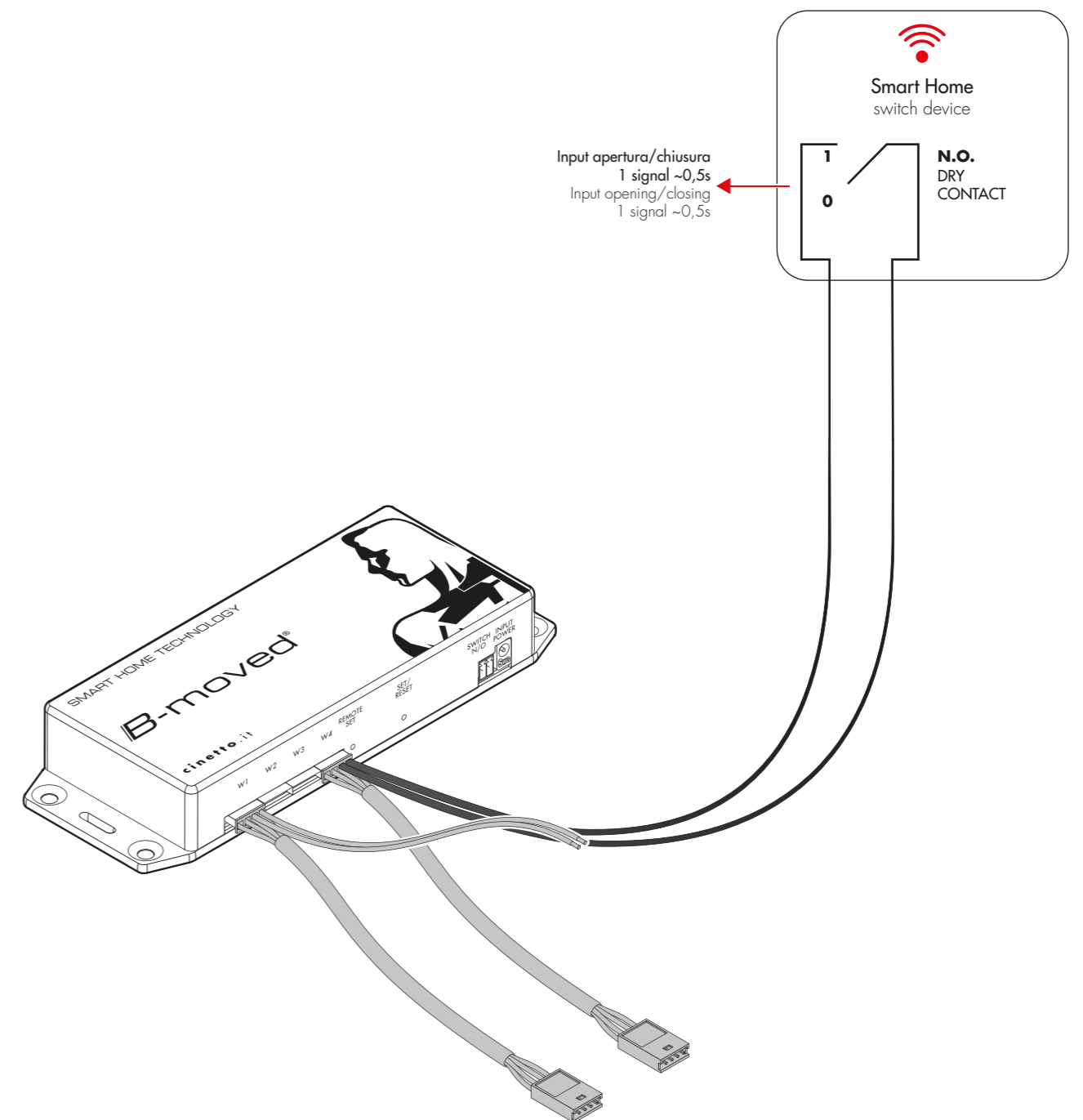



**Non utilizzare spray ed oli anti frizione o sblocca filetti sui cuscinetti o sulle ruote con O-ring dei pattini scorrevoli. Questo provoca lo scioglimento dei grassi dei cuscinetti rendendoli rumorosi oppure la rottura dell'O-ring.**  
Do not use any anti-friction oil or grease or thread-release spray on ball bearing or on wheels with O-ring, it can cause the melting of the inside ball bearing grease, making them noisy or causing the break of the O-ring of the wheels.

Tutte le parti del catalogo sono di proprietà della Cinetto F.Ili S.r.l.

È vietata qualsiasi imitazione e copia delle illustrazioni, della grafica e la riproduzione, anche parziale, del presente catalogo senza autorizzazione.

I disegni tecnici e le informazioni dimensionali, incluse le illustrazioni, riportate in questo catalogo non sono vincolanti. L'azienda si riserva il diritto di apportare modifiche a fini migliorativi.  
Tutte le dimensioni sono in mm, se non diversamente specificate.

Si declina ogni responsabilità per errori di stampa.

All constituents of the catalogue are the property of Cinetto F.Ili S.r.l.

Reprint of the catalogue or extracts thereof, reprinting or imitation of the illustrations or imitation of the design is forbidden without permission.

The technical representations and dimensional information in this catalogue are non-binding, including those in the illustrations and drawings. Right reserved to make design improvements.  
All dimensions are in mm unless otherwise specified.

No liability accepted for printing errors of the catalogue.

Rilasciato da - Issued by  
Cinetto F.Ili S.r.l.  
Via Meucci, 4 - 35030 Rubano (PD) Italy

Tel. +39 049 8977211 - Fax +39 049 635822

Internet: [www.cinetto.it](http://www.cinetto.it) - Email: [info@cinetto.it](mailto:info@cinetto.it)

Ottobre 2021  
© by Cinetto F.Ili S.r.l.  
All rights reserved.  
Printed in Padova - Italy



**Sede Legale e Officina di Produzione**

Via Meucci, 4 - 35030 Rubano (PD) Italy

[www.cinetto.it](http://www.cinetto.it) - [info@cinetto.it](mailto:info@cinetto.it)

**Sede Amministrativa, Magazzino e Punto Vendita**

Via Rossi, 5/A - 35030 Rubano (PD) Italy  
Tel. +39 049 8977211 - Fax +39 049 635822  
C.F./P.I. (VAT) (IT) 00277120283

