



Accuride[®]
Always Moving Forward



QuickShip

Product Catalogue

English / French / German versions

www.accuride-europe.com

Product index

Index des produits
Produktindex

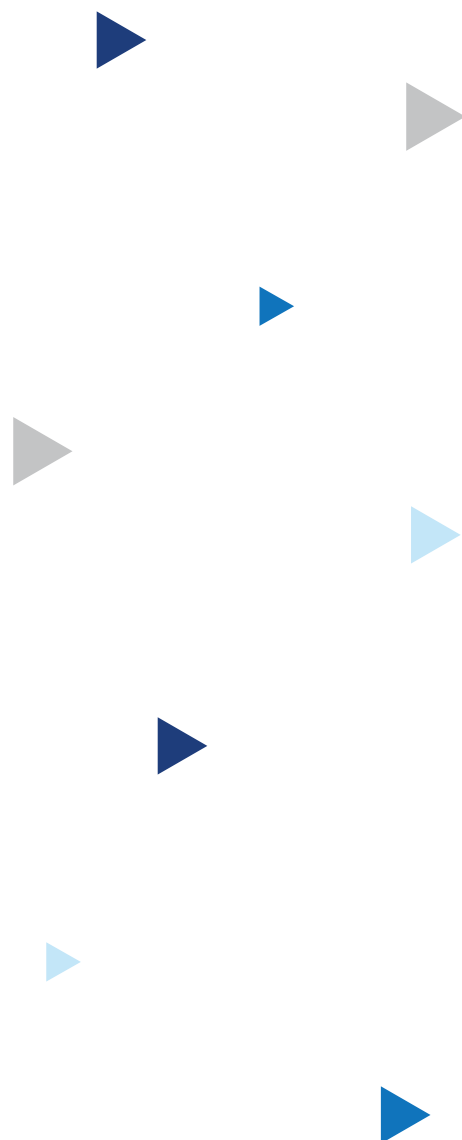

Introduction

The most comprehensive range of off-the-shelf telescopic slides in the world

Accuride has been at the forefront in the design and manufacture of telescopic slides and access and movement systems since 1962.

Our products ensure the smooth movement of sliding components, contributing significantly to optimum space utilization, efficient storage and easy access for repair and maintenance.

Quality

With extensive first-class manufacturing and testing facilities, we are able to offer quality components that will perform reliably over the lifetime of your product.

All our production facilities are registered to **ISO 9001:2008** with the German plant certified to both **ISO 9001:2015** and to the **ISO 14001:2009** Environmental Standard. The Accuride plant in Mexicali has an established programme that adheres to the **ISO 14001** standards and policies.

Local availability and fast delivery

Our highly successful **Quick Ship Programme** is designed for customers who require an off-the-shelf service.

Quick Ship Programme covers an extensive range of slides and ancillary products and is available through the widespread Accuride sales and distribution network, as well as for purchase directly from our dedicated online shop at www.accuride-europe.com

Our distribution partners, backed by Accuride's design and technical teams, are expert in recommending the right slide for integration into your product.

Please contact us for details of your local Accuride distribution partner.

This catalogue is available in print, or via our website, www.accuride-europe.com

As market demand changes Accuride may alter the products included in the **Quick Ship Programme** and we reserve the right to alter specifications without notice.

Your local Accuride distributor or our online advisors will be able to advise you on product availability.



Telescopic slides

Glissières télescopiques

Teleskopschienen

100% extension / course 100% / Vollauszug

2431

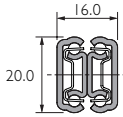

20kg **p36**

2731CL

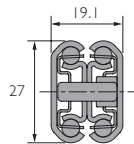

30kg **p41**

3732

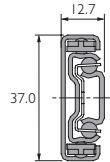

40kg **p54**

2601

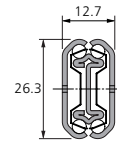

45kg **p37**

2642

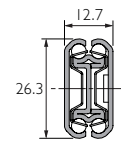

45kg **p38**

7400-50SC

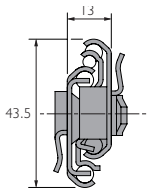

45kg **p88**

3832EC-B

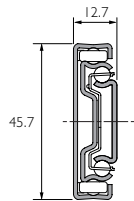

45kg **p62**

3832TR/HDTR

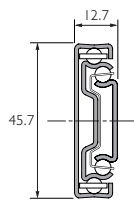

45kg **p66**

3832DO

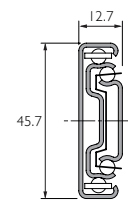

45/50kg **p60**

3832SC/HDSC

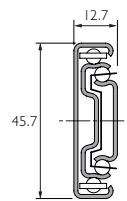

45/50kg **p64**

3832

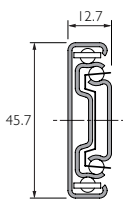

50kg **p56**

DH3832

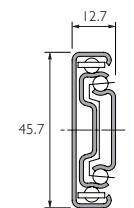

50kg **p58**

DA5321

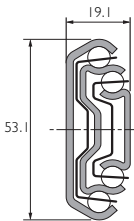

50kg **p74**

5417EC

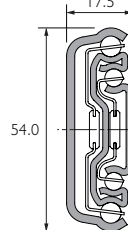

55kg **p84**

2907

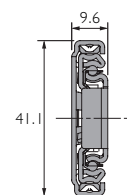

55kg **p42**

5517-50

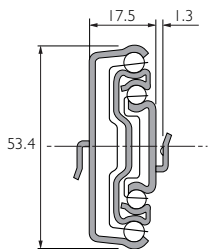

55kg **p85**

3320-50

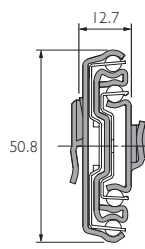

60kg **p48**

5517-60

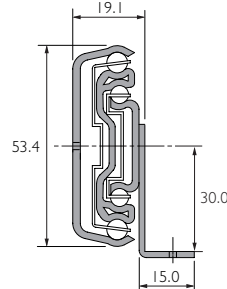

60kg **p86**

3301-60

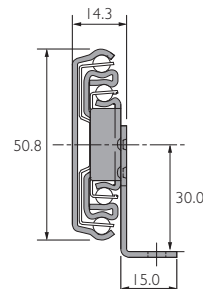

60kg **p45**

DS0330

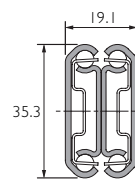

65/80kg **p25**

3301

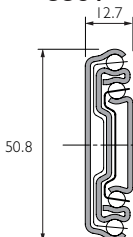

68kg **p44**

3307

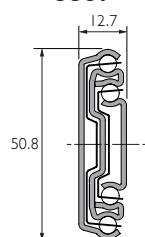

68kg **p46**

3308

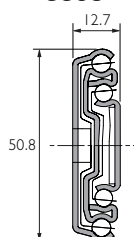

68kg **p47**

0301

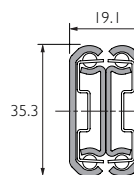

70kg **p22**

0305

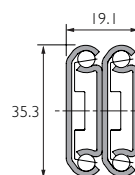

70kg **p23**

Telescopic slides

Glissières télescopiques

Teleskopschienen

100% extension / course 100% / Vollauszug

DS0305

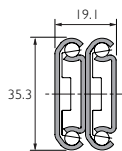

70kg **p24**

DS3031

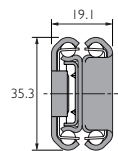

80kg **p43**

3507

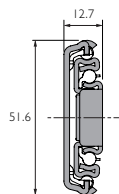

82kg **p49**

DS3557

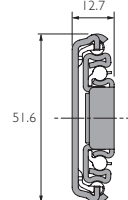

90kg **p50**

5417

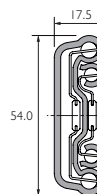

90/100kg **p83**

5343/5344

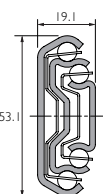

100kg **p81**

5321EC

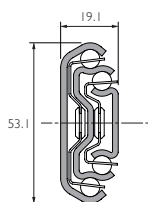

100kg **p77**

3607

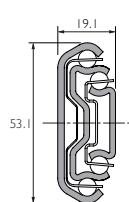

120kg **p51**

5321-60

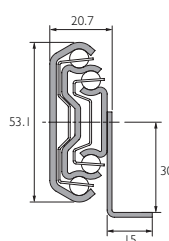

120kg **p79**

DS5322

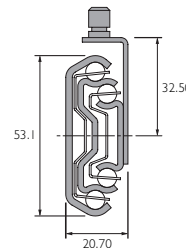

120kg **p80**

5321SC

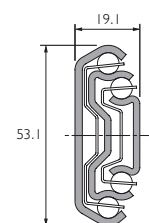

120kg **p78**

3657

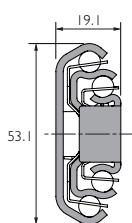

124kg **p53**

5321

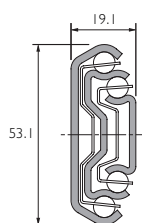

140/160kg **p76**

7957

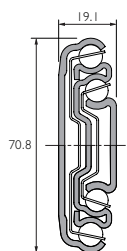

160kg **p89**

DS5321

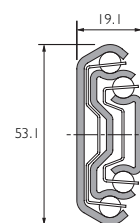

160/180kg **p75**

0522

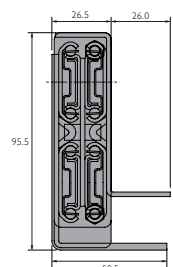

180kg **p26**

9301-E

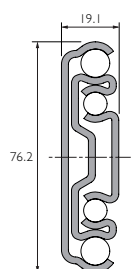

272kg **p93**

DP9301-E

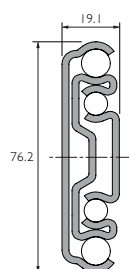

272kg **p91**

9308-E

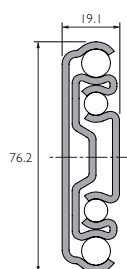

272kg **p95**

DA4160

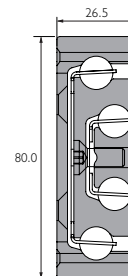

300kg **p72**

DA4140

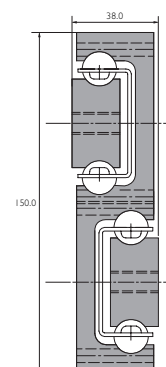

400/600kg **p70**

Telescopic slides

Glissières télescopiques

Teleskopschienen

75% extension / course 75% / Vollauszug

2421

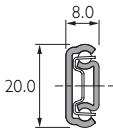

16kg **p35**

DS2728

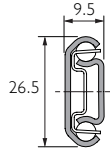

20kg **p39**

2109

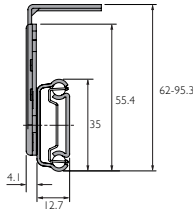

35kg **p31**

2132

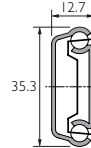

35/50kg **p32**

2132DO

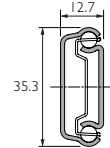

35/50kg **p34**

0201

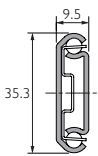

50kg **p20**

0204

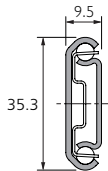

65kg **p21**

DS2028

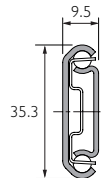

60/65kg **p30**

DA4120

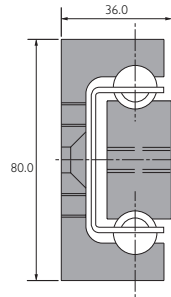

438/550kg **p70**

Two-way travel / Double course / Auszug in beide Richtungen

2002

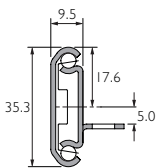

35kg **p28**

3630

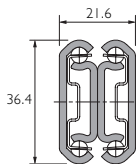

45kg **p52**

2026

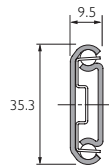

50kg **p29**

6026

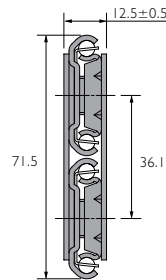

100kg **p87**

Linear motion slides

Guidages linéaire

Linearbewegungsschienen

Friction guides / Guidages à friction / Gleitführungen

DFG115-CASSAA DFG115-CASSMA DFG115-CASSNA

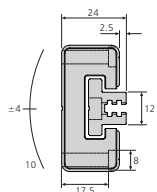

50kg p100

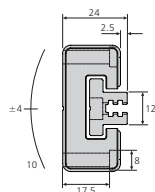

50kg p103

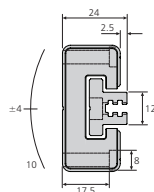

50kg p106

Recirculating ball guides / Patins à billes de recirculation / Linearführungen mit Kugelumlauf

DS0115RC

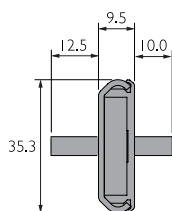

30kg p112

DA0115RC/RCH

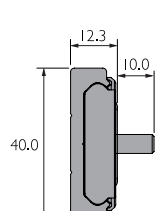

130kg p109

DA0116RC

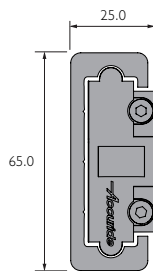

360kg p114

Caged ball bearing guides / Roulements à cages à billes / Linearführungen mit Kugelkäfig

2415

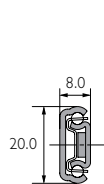

18.5kg p120

1312

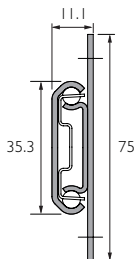

60kg p119

0115RS

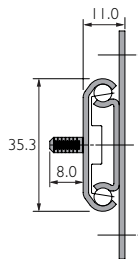

60kg p117

Pocket door slides

Glissières pour porte coulissante escamotable

Schienen für einschiebbare Türen

1319	5.5kg	p128	1234	14kg	p122
1312	5.5kg	p123	1316/1319	25kg	p125
1321	14kg	p130	1432	34kg	p132

Hinge recommendations / Recommandations concernant les charnières / Empfohlene Scharniere p134

Mounting kits and accessories

Kits et accessoires de montage

Montage-Kits und Zubehör

Bracket kit / Kit d'équerres / Zubehör-Winkelbausatz

2109/2132/3732/3832 series	p136
9301/9308/7957	p137
5321/5321EC	p142

Sliding door mounting kit / Kit de montage pour portes coulissantes / Schiebetürbeschläge p147

Mounting brackets for sliding doors / Équerres de montage pour portes coulissantes / Montagewinkel für Schiebetüren..... p150

Soft close mechanism / Fermeture automatique avec amortissement / Gedämpfter Selbsteinzug p153

Damper mechanism/ Amortisseur pour ralentir la porte / Dämpfermechanismus..... p154

Locking handle kit / Kit de poignées de verrouillage / Verriegelungshebel p156

Cable carriers / Porte-câble / Kabelträger..... p162

Enclosure bracket kits / Kit d'équerres pour montage en rack / Gehäuse-Montagewinkeln p164

Media hardware

La gamme d'équipements multimedia

Media-Hardware-Kollektion

Mechanical lift / Système de levage mécanique / Mechanischer Lift p166

Keyboard trays / Plateau pour clavier / Tastaturauszug p169

CPU holders / Supports pour unité centrale / CPU-Halter p171

Slide and tilt system

Système coulissant et basculant

Teleskopschiene mit Kippsystem

DA4190

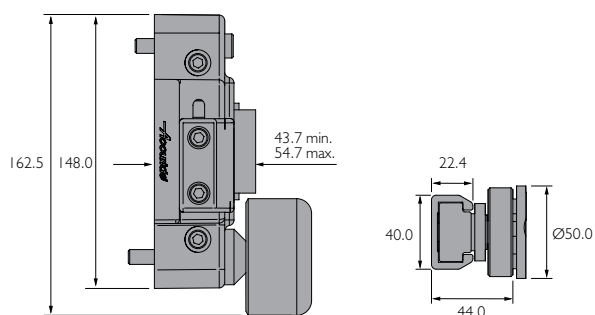

p176